

LB-75-20-A Standard Gain Horn Antenna 10-15GHz 20dB Gain Rectangular Waveguide Interface

Standard Gain Horn Antenna Operating From 10GHz to 15GHz With a Nominal 20dB Gain With Rectangular Waveguide Interface



Product Information

SKU	LB-75-20-A
-----	------------

Description

Standard Gain Horn Antenna LB-75-20-A, operating from 10 to 15GHz with a nominal 20dB gain and low VSWR 1.1:1 with FBP120 output. The model LB-75-20-A has uniform gain through its frequency span, providing efficient performance characteristics and directionality. Constructed of lightweight corrosion-resistant aluminum, the antenna will provide years of trouble-free indoor and outdoor service. This standard gain horn antenna is linearly polarized and ideally suited for EMI testing, direction finding, surveillance, antenna gain and pattern measurements and other applications.

Technical Specification

Electrical Specification		Interface	
Frequency, Min (GHz)	10	Output Type	Waveguide
Frequency, Max (GHz)	15	Flange Style	Square
Waveguide Type	Rectangular	Flange Type	Cover
Waveguide Size EIA WR	WR75	Flange Designation	FBP120(UBR120)
Gain, Typ (dBi)	20	Mechanical Specification	
Polarization	Linear	Figure	A Type
3dB Beamwidth, E-Plane, Typ (Deg.)	16	Body Material	Al
3dB Beamwidth, H-Plane, Typ (Deg.)	17	Finish	Chemical Conversion Coating, Gray Paint
Cross Pol. Isolation, Typ (dB)	35	Size, W (mm)	108
VSWR, Typ	1.1:1	Size, H (mm)	83
		Size, L (mm)	155
		Weight, (kg)	0.17

Additional Information

Application	General Purpose Indoor & Outdoor, Fixed	Solution for	Gain Reference Antenna Measurement Reflector Feed Far-field Measurement System Intergration Material Measurement
-------------	---	--------------	---

Outline Drawing

FBP120 Output (P/N: LB-75-20-A)

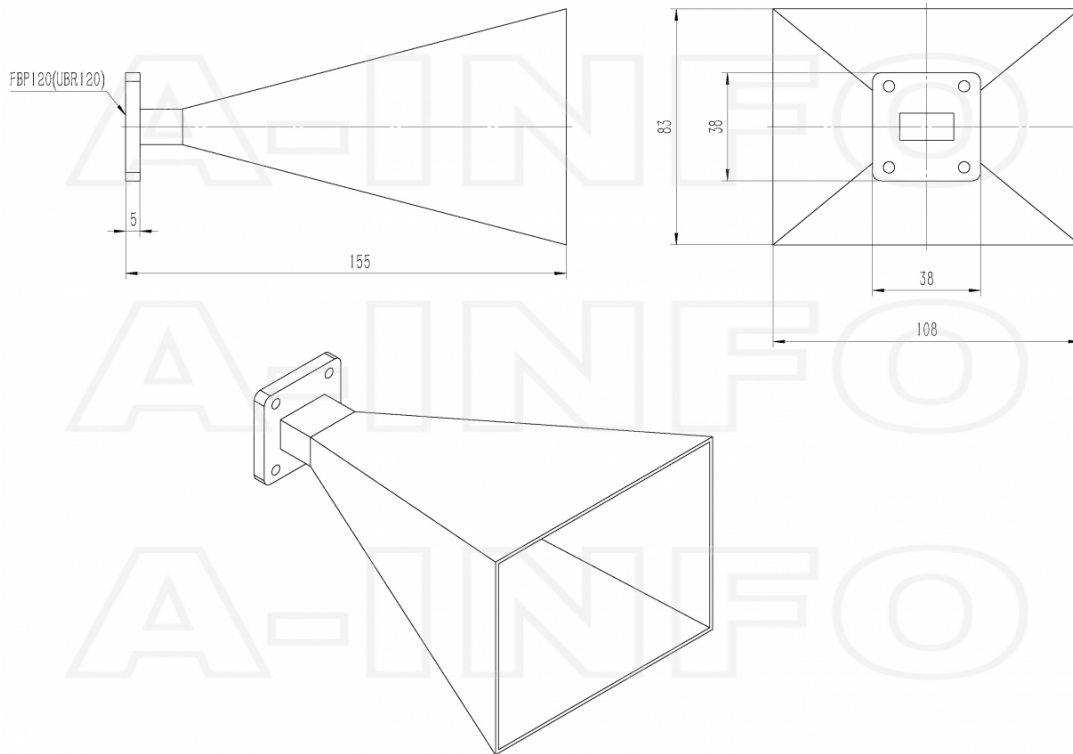

Flange Drawing

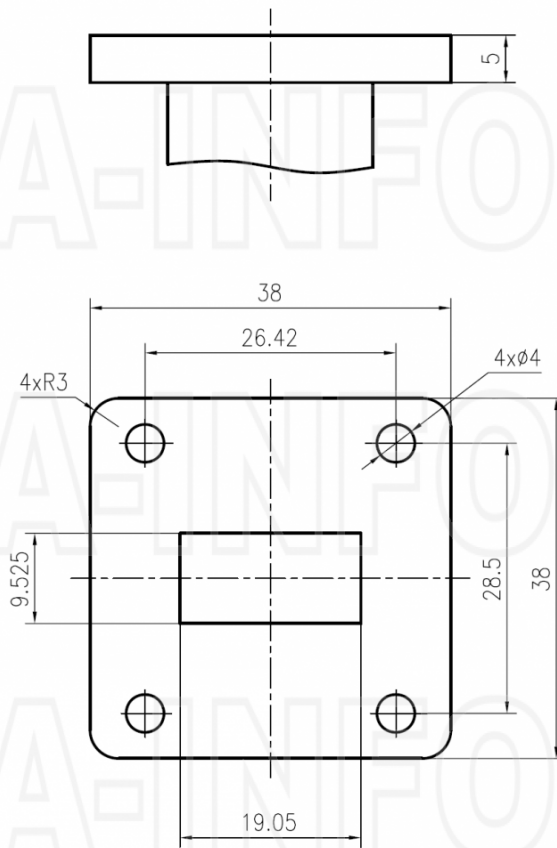

FBP120

Typical Test Results

Gain

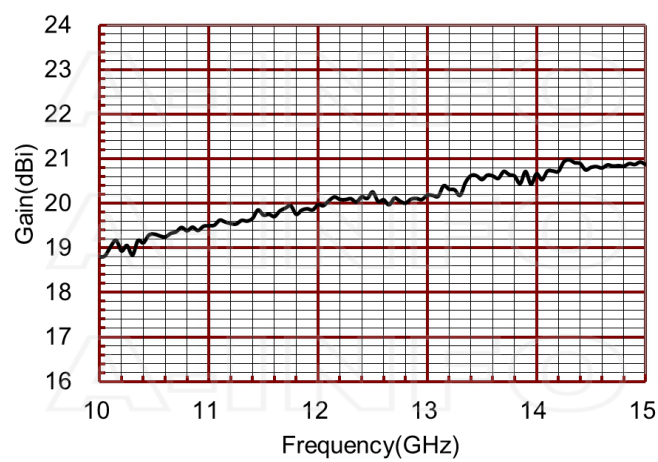

Antenna Factor

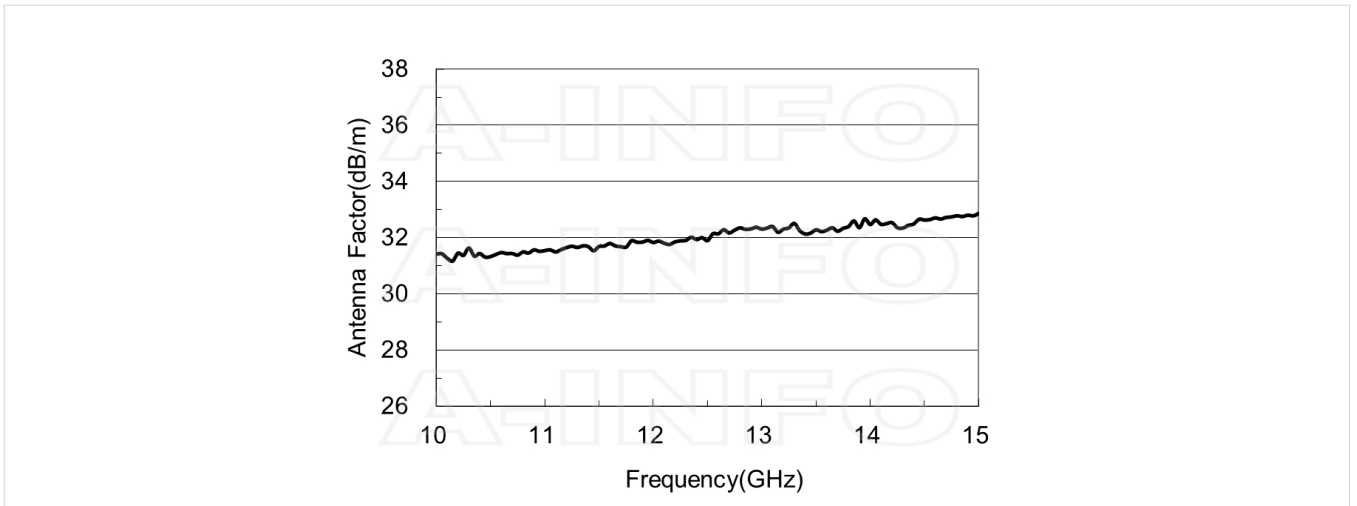

Antenna Factor (Table)

Frequency(GHz)	Gain(dBi)	Antenna Factor(dB/m)
10.00	18.79	31.42
10.50	19.31	31.33
11.00	19.50	31.54
11.50	19.73	31.69
12.00	19.97	31.83
12.50	20.25	31.89
13.00	20.19	32.30
13.50	20.53	32.28
14.00	20.66	32.47
14.50	20.81	32.63
15.00	20.87	32.86

Cross Polarization Isolation

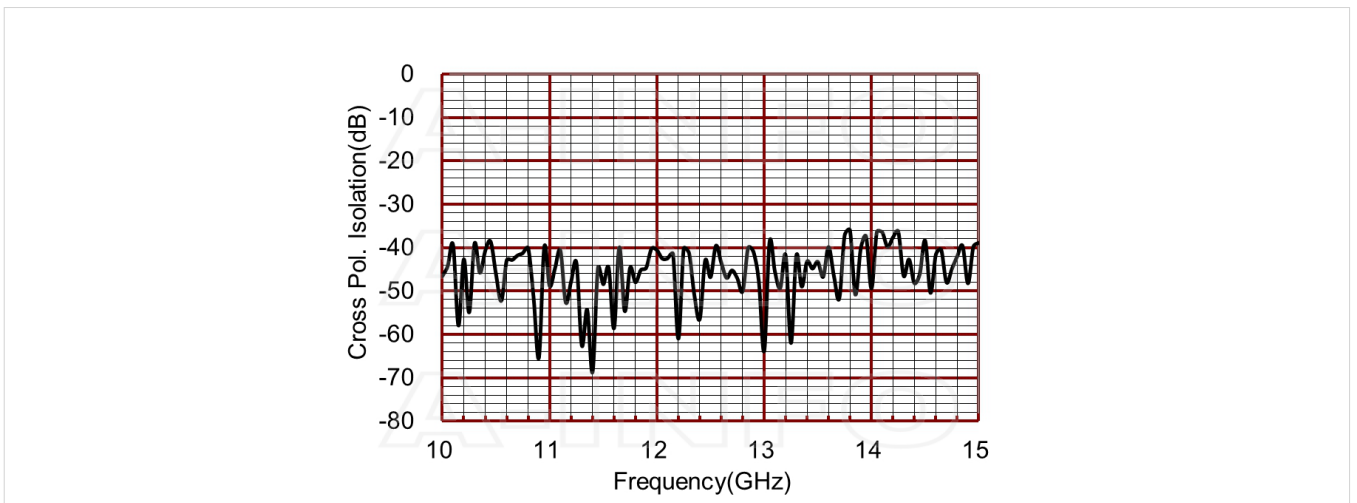

VSWR

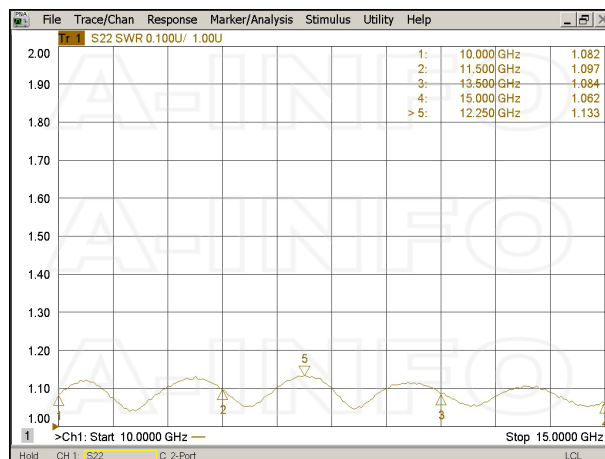

Pattern

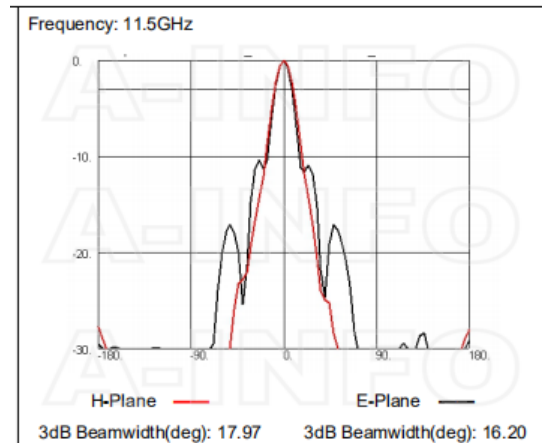
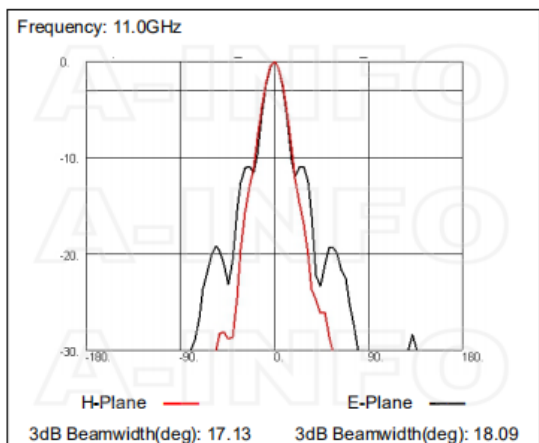
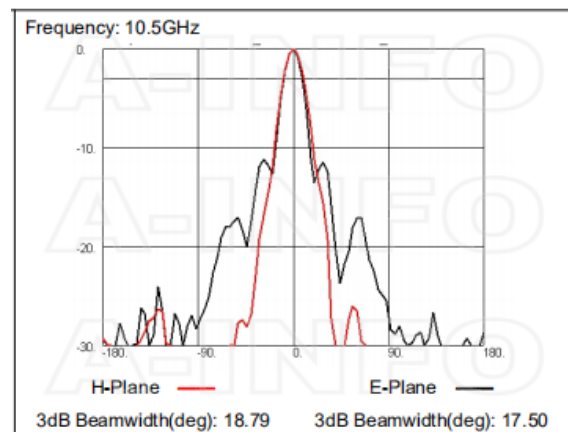
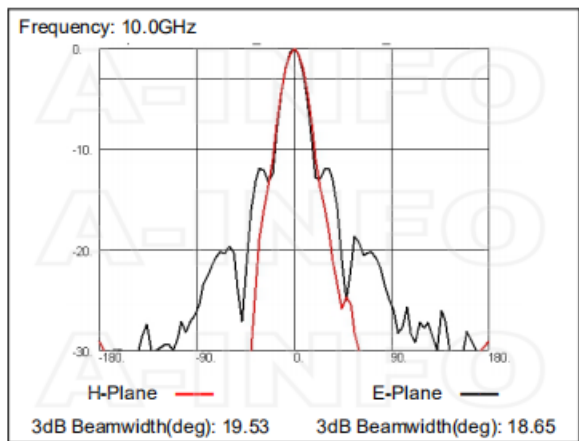

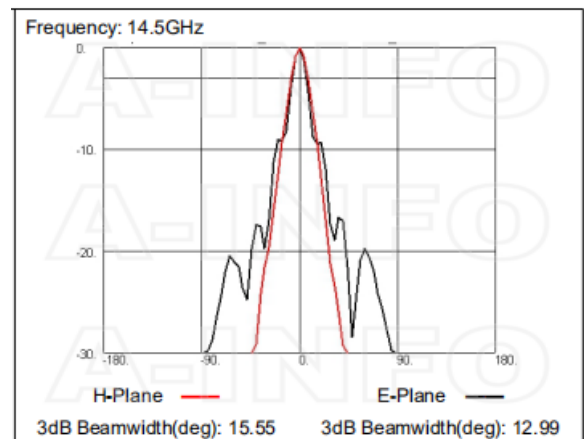
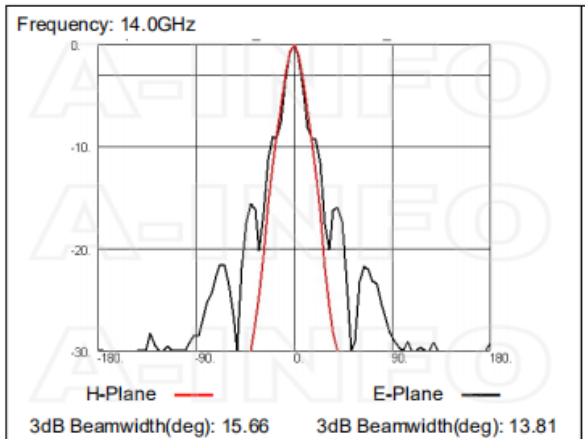
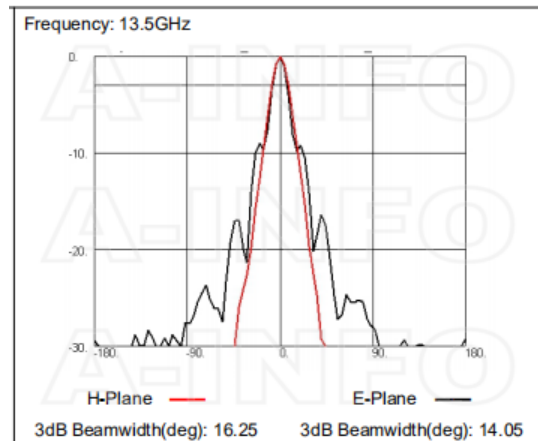
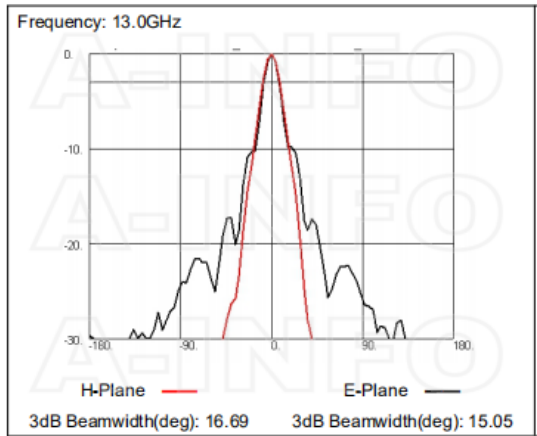
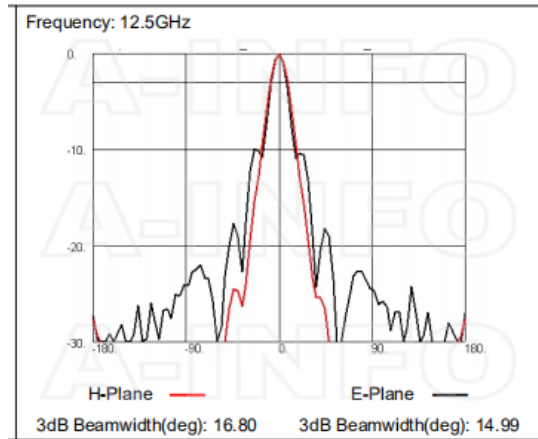
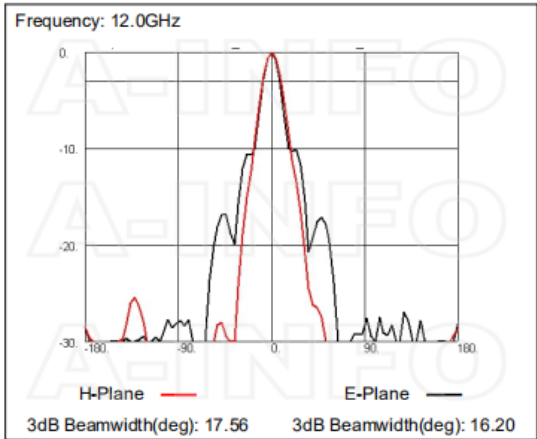

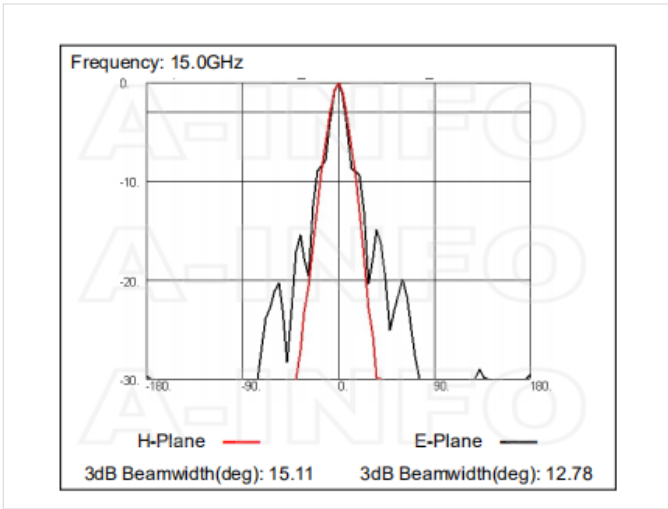

Related Products



75WCAN Right Angle Rectangular Waveguide to Coaxial Adapter 10-15GHz WR75 to N Type Female



75WCANM Right Angle Rectangular Waveguide to Coaxial Adapter 10-15GHz WR75 to N Type Male



75WCAS Right Angle Rectangular Waveguide to Coaxial Adapter 10-15GHz WR75 to SMA Female



75WCASM Right Angle Rectangular Waveguide to Coaxial Adapter 10-15GHz WR75 to SMA Male



75WCAT Right Angle Rectangular Waveguide to Coaxial Adapter 10-15GHz WR75 to TNC Female



75WCATM Right Angle Rectangular Waveguide to Coaxial Adapter 10-15GHz WR75 to TNC Male



75WCA7 Right Angle Rectangular Waveguide to Coaxial Adapter 10-15GHz WR75 to 7mm



75WCA3.5 Right Angle Rectangular Waveguide to Coaxial Adapter 10-15GHz WR75 to 3.5mm Female



75WCA3.5M Right Angle Rectangular Waveguide to Coaxial Adapter 10-15GHz WR75 to 3.5mm Male



75WCAK Right Angle Rectangular Waveguide to Coaxial Adapter 10-15GHz WR75 to 2.92mm Female



75WCAKM Right Angle Rectangular Waveguide to Coaxial Adapter 10-15GHz WR75 to 2.92mm Male



75WCA2.4 Right Angle Rectangular Waveguide to Coaxial Adapter 10-15GHz WR75 to 2.4mm Female



75WCA2.4M Right Angle Rectangular Waveguide to Coaxial Adapter 10-15GHz WR75 to 2.4mm Male



75WECAN Endlaunch Rectangular Waveguide to Coaxial Adapter 10-15GHz WR75 to N Type Female



75WECAS Endlaunch Rectangular Waveguide to Coaxial Adapter 10-15GHz WR75 to SMA Female



75WECAK Endlaunch Rectangular Waveguide to Coaxial Adapter 10-15GHz WR75 to 2.92mm Female



M4x18 Hex_Pack WR112- WR51 Flange Assembly Pack

Similar Products

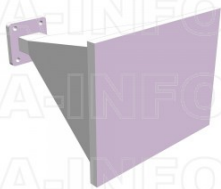

LB-75-20-ASPO Standard Gain Horn Antenna 10-15GHz 20dB Gain Rectangular Waveguide Interface



LB-75-20-C-SF Standard Gain Horn Antenna 10-15GHz 20dB Gain SMA Female

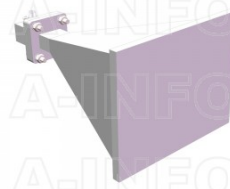

LB-75-20-C-SFSP0 Standard Gain Horn Antenna 10-15GHz 20dB Gain SMA Female



LB-75-20-C-NF Standard Gain Horn Antenna 10-15GHz 20dB Gain N Type Female

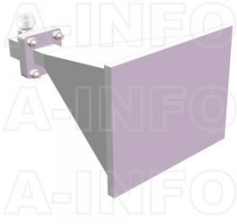

LB-75-20-C-NFSPO Standard Gain Horn Antenna 10-15GHz 20dB Gain N Type Female



LB-75-20-C-TF Standard Gain Horn Antenna 10-15GHz 20dB Gain TNC Female

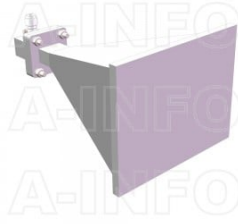

LB-75-20-C-TFSP0 Standard Gain Horn Antenna 10-15GHz 20dB Gain TNC Female



LB-75-20-C-7 Standard Gain Horn Antenna 10-15GHz 20dB Gain 7mm

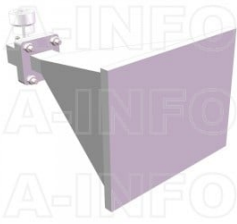

LB-75-20-C-7SPO Standard Gain Horn Antenna 10-15GHz 20dB Gain 7mm



LB-75-20-C-3.5F Standard Gain Horn Antenna 10-15GHz 20dB Gain 3.5mm Female

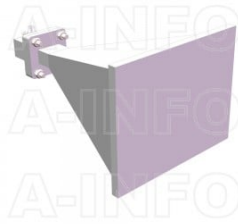

LB-75-20-C-3.5FSPO Standard Gain Horn Antenna 10-15GHz 20dB Gain 3.5mm Female

About this Datasheet

<ul style="list-style-type: none"> ● Product Information Product Link: https://www.ainfoinc.com/lb-75-20-a-standard-gain-horn-antenna-10-15-ghz-20db-gain-fbp120 Data subject to change without notice. © A-INFO INC. 2023. All Rights Reserved 	<ul style="list-style-type: none"> ● Contact Us Address:dd 60 Tesla, Irvine, CA 92618, USA Website: www.ainfoinc.com Email: sales@ainfoinc.com 	<ul style="list-style-type: none"> ● Phone & Fax Phone: +1-949-639-9688 +1-949-639-9608 Fax: +1-949-639-9670
---	--	---